



Starling Madison Lofquist, Inc.
Consulting Structural and Forensic Engineers

5224 South 39th Street, Phoenix, Arizona 85040
tel: (602) 438-2500 fax: (602) 438-2505 ROC#291316 www.smleng.com

Pegasus Solar
100 West Ohio Avenue
Richmond, CA 94804

October 18, 2017

Page 1 of 3

Attn: Mr. Kai Stephan, CEO

Subject: Pegasus Solar™ L-Foot Allowable Loads

SML Job No.: 182-15

Dear Mr. Stephan:

We have analyzed the Pegasus Solar™ L-Foot roof mount system and determined that, for the configurations and criteria described below, it is in compliance with the applicable sections of the following reference documents:

- Codes: ASCE/SEI 7-05 & 7-10 Min. Design Loads for Buildings & Other Structures
International Building Code 2009, 2012 & 2015 Editions
International Residential Building Code 2009, 2012 & 2015 Editions
- Other: Aluminum Design Manual, ADM 2010 & 2015 Editions

This letter is to address the use and allowable loads for the Pegasus Solar™ L-Foot as shown in diagram LF1 below. We have reviewed the test data for the L-Foot prepared by Applied Materials & Engineering (AME), tested September 20, 2017 as well as typical loading and anchorage conditions for common rail type solar racking systems. We have determined that, subject to the limitations outlined below, the Pegasus Solar™ Light Speed L-Foot is suitable for most rooftop solar racking systems.

The primary structural element of the mounts is a standard 5/16" dia. by 4 1/2 inch long lag screw. The lag screw is intended to be anchored into a timber roof joist or truss with a minimum embedment of 2 inches. The AME tests simulated this configuration using 1/2" plywood and a 2x4 wood member. The AME report indicates the failure mode is the fracture of the cast part for both tension and shear loading.

The results of the AME report give the average allowable load for pullout (uplift) and lateral shear for anchorage in Doug Fir timber with a specific gravity (G) of 0.50 as follows:

Allowable Uplift = 1254 lbs, Allowable Shear = 1536 lbs

The values provided above were developed by taking the lowest of three tests divided by a factor of safety of 2.0 for aluminum rupture failure. Additionally, there was a slight modification of the part to decrease the thickness of the vertical serrated portion of the L-Foot after the AME test was completed. This reduced section was accounted for by reducing the tested results by a factor equal to the new cross-sectional area divided by the original cross-sectional area. This resulted in a reduction of 11% from that determined by the AME test. These values do not include any additional increases or load factors, and it is up to the end user to determine any increases permissible by the code. The tension test load was applied at the top of the slotted hole and the shear test load was applied at the bottom of the slotted hole. Any adverse effects due to additional height or eccentricity of connected components shall be considered by the end user of this letter.

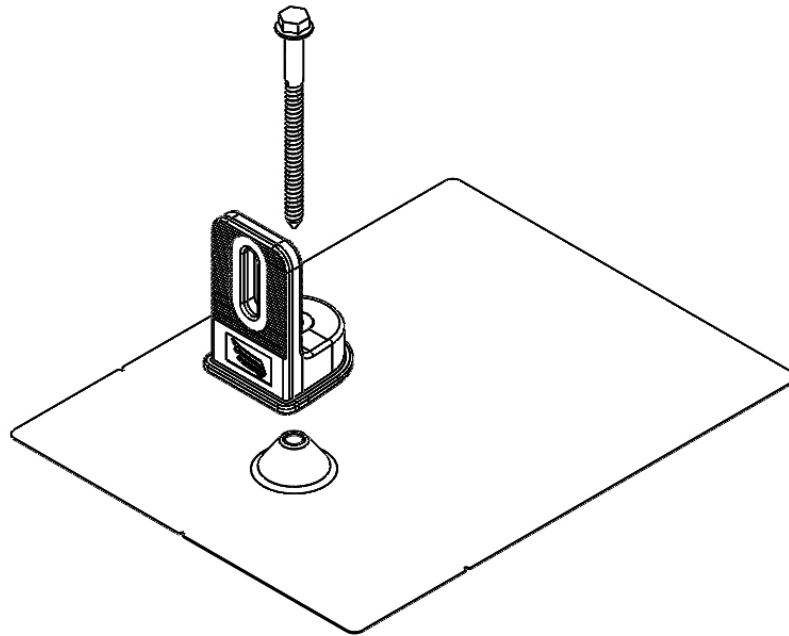

Diagram LF1: Pegasus Solar™ L-Foot

The Pegasus Solar™ L-Foot as shown in diagram LF2 below mounted to the top of the Pegasus Tile Replace Mount is an acceptable installation and use of the L-Foot. When the Pegasus L-Foot is attached to the Pegasus Tile Replace Mount and not directly to the wood member, the Tile Replace Mount becomes the limiting factor in all directions. When installing in this manner refer to the “Pegasus Solar Tile Replace for Rails PE Certification Letter” for specific capacities.

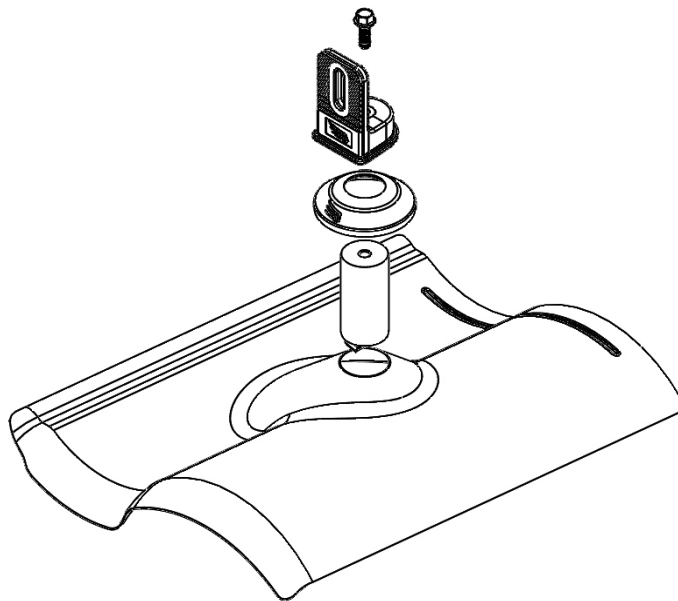

Diagram LF2: Pegasus Solar™ L-Foot on Pegasus Tile Replace Mount

Notes – Tested values are based on the following criteria:

1. 2.0” minimum penetration of lag screw into 2x roof framing, excluding the tapered tip portion.
2. PV panel must comply with mechanical load requirements of UL 1703 OR 2703.

Our analysis assumes that the connections and associated hardware are installed in a workmanlike manner in accordance with the Pegasus Solar™ L-Foot Mount Installation Manual and generally accepted standards of construction practice. It is the responsibility of the contractor to verify that the strength of the roof framing meets the minimum properties used in the tests and can safely support the maximum imposed loads stated within this document. Starling Madison Lofquist, Inc. and Pegasus Solar™ assume no liability beyond what is specifically shown in this letter. Additional information is available at the Pegasus Solar™ web site, <http://pegasussolar.com/>

Please feel free to contact me at your convenience if you have any questions.

Respectfully yours,



Tres J. Warner, P.E.
Design Division Manager

Jesse Light, P.E.
Sr. Structural Engineer